

# DUETTE®

with

ultra  
glide™

## HONEYCOMB SHADES

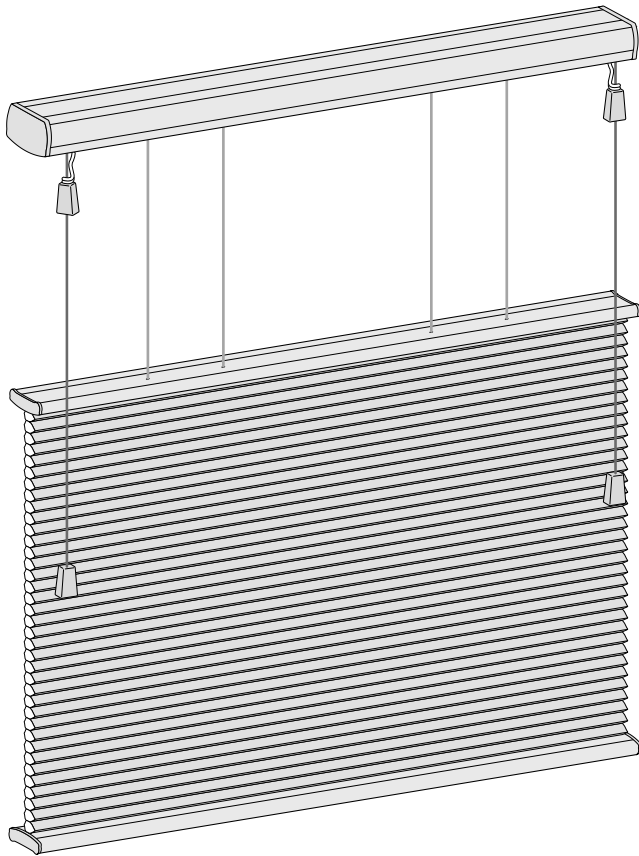

### Installation and Care Instructions for Duette® with UltraGlide™ Specialty Rectangular Shades

Includes Duette UltraGlide Top-Down, Top-Down/Bottom-Up, and Two-On-One Headrail shades

**HunterDouglas**  
WINDOW FASHIONS

## FIRST THINGS FIRST . . .

Thank you for choosing Duette® with UltraGlide™ shades. With proper installation and care, your new shades will provide many years of beauty and performance.

Duette with UltraGlide specialty rectangular shades include: top-down/bottom-up; free-hanging top down; and two-on-one headrail. To install any one of these shades, you will need a few basic tools:

- Measuring Tape
- Power Drill and Drill Bits
- Long Flat Blade Screwdriver
- Phillips Screwdriver
- Scissors
- Carpenter's Level

In addition to the tools, you will need a supply of screws to attach the installation brackets. No. 6 Hex Head screws are suitable for the 3/4" bracket. Expansion or toggle bolts are required with non-solid surfaces, such as drywall or lath and plaster.

Installation brackets are attached either inside or outside the window opening, depending upon whether the shade was ordered as an *inside mount* or an *outside mount*. The end mount option is used when no other type of mount will work.

The installation hardware you received with your shades was specified at the time the shades were ordered, based upon your particular installation needs. When mounting a shade on the outside of a window opening, spacer blocks or extension brackets may be used with installation brackets to allow the shade to clear obstructions. Hold down brackets are optional installation hardware used to prevent the bottom of the shade from swaying.

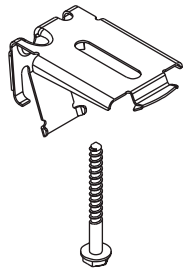

STANDARD  
3/4"  
INSTALLATION  
BRACKET  
(INSIDE AND  
OUTSIDE)

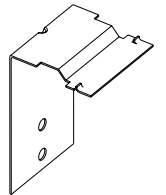

END MOUNT  
INSTALLATION  
BRACKET  
(INSIDE  
MOUNTS)

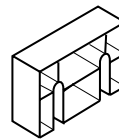

SPACER  
BLOCK

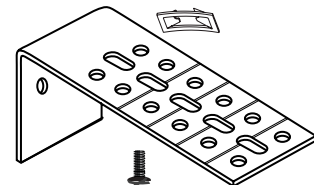

EXTENSION BRACKET  
WITH MACHINE SCREW  
AND SPEED NUT

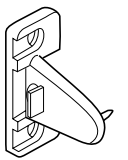

HOLD  
DOWN  
BRACKET

The installation instructions are organized into three simple steps — as easy as 1, 2, 3. Before beginning, read the instructions through to acquaint yourself with the procedures.

# 1 ATTACH THE INSTALLATION BRACKETS

## BRACKET SPACING

Bracket spacing is the same for both inside and outside mounts. Two standard installation brackets are positioned on the mounting surface so their centerlines will be 2" from the ends of the shade.

If more than two brackets are required (see chart below), space additional brackets evenly between the two end brackets. Measure and mark all screw hole locations.

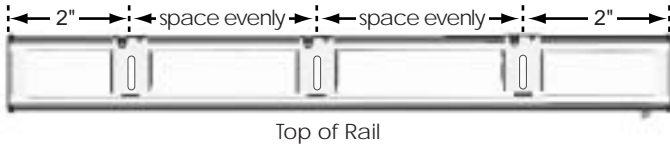

## INSIDE MOUNT APPLICATIONS

### Installation Brackets Required

SHADE WIDTH	NUMBER OF INSTALLATION AND OPTIONAL EXTENSION BRACKETS REQUIRED
12" – 31"	2
32" – 79"	3
80" – 96"	4

With inside mount applications, one mounting screw is used to attach the top of each standard installation bracket to the top sill of the window opening.

Locate the screws on the centerlines you marked, and position the brackets so the front edges are aligned. To attach the brackets, the flat surface of the sill must be at least 3/4" deep. To fully recess the

shade, the flat surface must be at least 2 1/4" deep. You will need extra clearance if the shade must cover such things as window cranks, handles, locks, etc. Place a #6 Hex Head screw through the center hole in the top of the bracket to inside mount the bracket to the window opening.

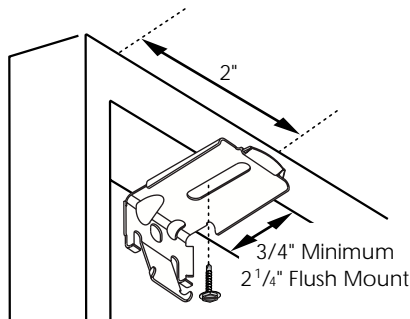

## OUTSIDE MOUNT APPLICATIONS

Mount the ends of the installation brackets on a flat vertical surface at least 5/8" high. Two screws are

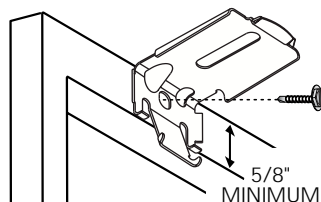

used to attach each bracket. Center the brackets on the centerlines you marked, and attach them with screws through the two holes in the back of the bracket. The tops of the installation brackets must be perfectly level.

## SPACER BLOCKS

Spacer blocks are used to project the standard installation bracket away from the mounting surface when additional shade clearance is needed. Each spacer block adds an extra 1/2" clearance. Use a maximum of three blocks. Mount them with the solid sides facing the mounting surface. Check to be sure your mounting screws are long enough for a secure installation.

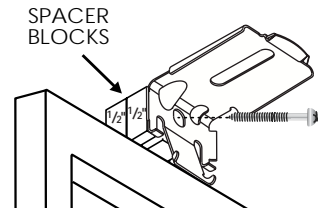

## EXTENSION BRACKETS

An extension bracket can project a standard installation bracket up to 3" from the mounting surface. Position the brackets on the marked centerlines, and attach each with two screws. The tops of all brackets must be perfectly level.

Connect the installation brackets with the machine screw and speed nut included with each extension bracket. Be sure to use the same hole on all the extension brackets, so each installation bracket projects the same distance from the mounting surface.

Between the rows of holes in the extension brackets, there are indentations in the metal where extra length may be cut off (a hack saw works well for this purpose). Trim the brackets *before* mounting them.

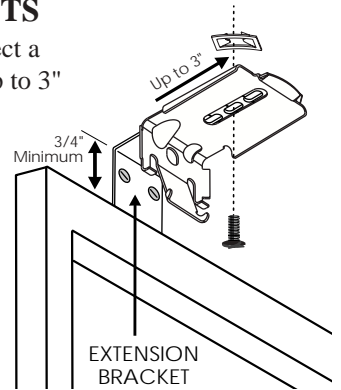

## END MOUNT BRACKETS

End mount brackets are used when the shade's headrail must span an open space and other mounting methods will not work. End mount brackets fit into small grooves on the top of the headrail. Pull the headrail end cap out about 1/2" to insert the bracket into the grooves. Repeat on the other end of the rail. If an arch shade shares the headrail with a standard shade, carefully insert the brackets under the arch fabric. As you insert the brackets, also reinsert the end caps.

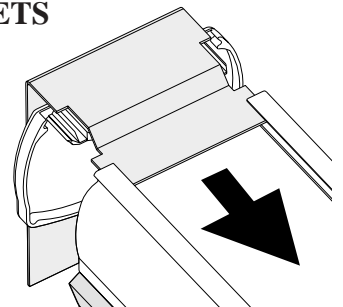

Hold the shade assembly in the window opening and mark where to drill holes for the mounting bracket screws. Use a level to make sure the headrail is perfectly horizontal. After marking and drilling the mounting screw holes, again

position the shade assembly in the window opening. Gently pull the fabric forward to install the mounting screws. Be very careful not to damage or wrinkle the fabric during the installation process.

**To fully recess the shade, the window opening must be at least 2 1/4" deep for 1/2", and 1" pleat sizes.**

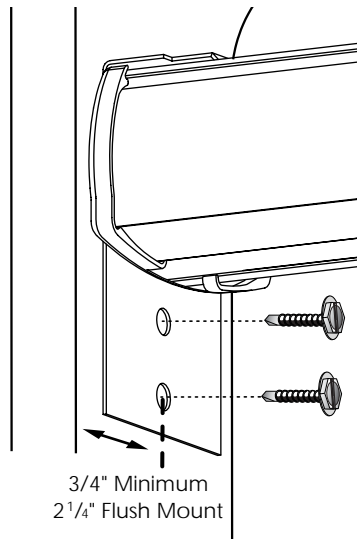

## 2 INSTALL THE SHADE ASSEMBLY

### STANDARD INSTALLATION BRACKETS

Unwind the cord from around the shade assembly and let the cord hang. With the front of the shade facing you, slip the headrail into the installation brackets with the nose of the brackets sliding under the front groove on the top of the rail. Be sure to catch the front "lip" of the bracket *under* the front edge of the rail. Gently roll the back of the rail up and push back to snaps it into place.

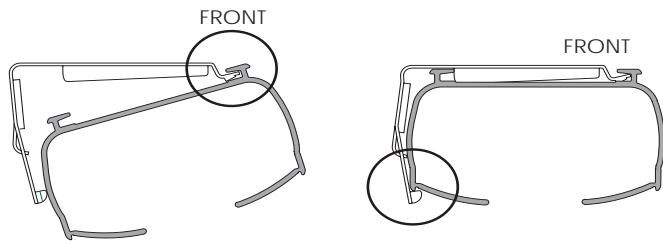

**To release the headrail from the bracket (release one bracket at a time):** Lower the shade approximately 4 inches while holding the headrail assembly. Use your thumb to push back on the bottom tab of the mounting bracket. After releasing the bottom edge, roll the back of the rail downward and out from the bracket.

If the bracket is stiff the rail may be difficult to remove. Use a flat-blade screwdriver wrapped with a soft cloth and push the blade against the bottom tab of the mounting bracket. Be careful not to scratch the finish on the back of the headrail.

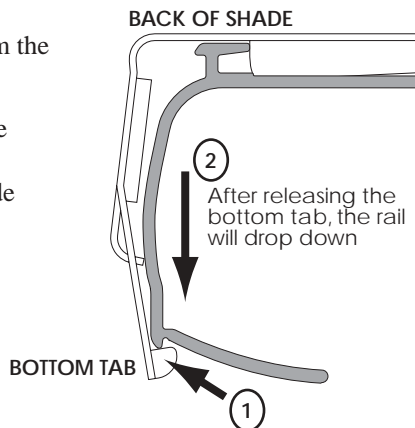

Push back against the tab using your thumb or a wrapped screwdriver blade

## 3 ADJUST THE SHADE ASSEMBLY

### THE POCKET AND FERRULE ASSEMBLY

Lower the shade by pulling the cord toward the center of the shade.

During the Duette® with Ultraglide™ shade fabrication process, the bottom rail is levelled and the shade drop is set to the height specified on your order. Check these adjustments by lowering the bottom rail to its lowest point. In the rare event you need to make a change, the following procedure should be undertaken.

Locate the "ferrule" seated in the pocket in the bottom rail. Pull the ferrule out of the pocket by pulling on the excess cord. The cord is wrapped one time around the ferrule. The necessary adjustments are made by sliding the ferrule up or down the cord to change the height and level of the bottom rail. To move the ferrule, first unthread one loop of the cord by pulling it out through the ferrule.

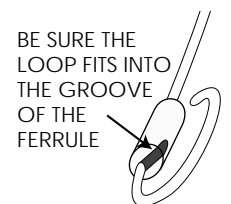
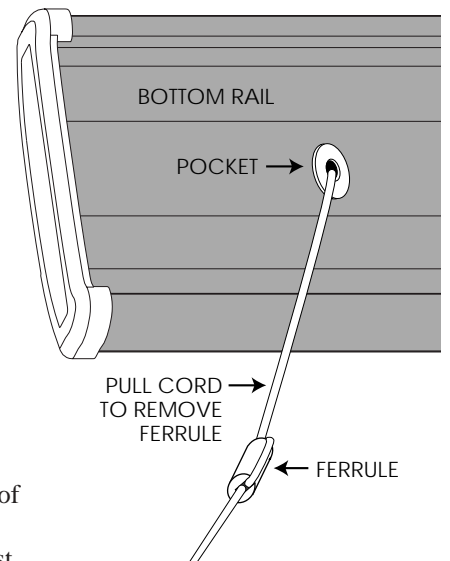

After making your adjustment, lock the ferrule in place by threading the cord through the top of the ferrule again, creating a loop that wraps around the piece. Make sure the loop fits in the groove on the side of the ferrule. Seat the ferrule back into the pocket in the bottom rail. Trim excess cord with scissors so that the cord is flush with the ferrule and the bottom rail.

### OPTIONAL HOLD DOWN BRACKETS

Lower the shade fully. Place the pins on the hold down brackets into the bottom rail end caps, and mark mounting hole locations. Attach the brackets with one screw through the side hole or two through the end holes. Bracket pins must be aligned and level.

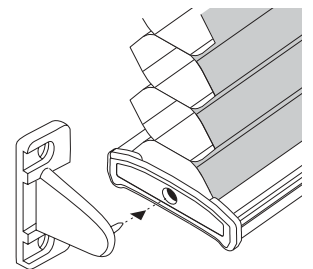

# 4 CHILD SAFETY

## ⚠ WARNING

To avoid entanglement and strangulation, keep cords out of the reach of young children. Also move cribs and furniture away from window covering cords.

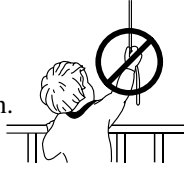

# 5 OPERATION AND CARE

## OPERATION

Keep the cord close to the fabric when raising or lowering the shade. Move the cord toward the center of the shade to release the shade. Pull the cord straight down with short strokes to raise the shade.

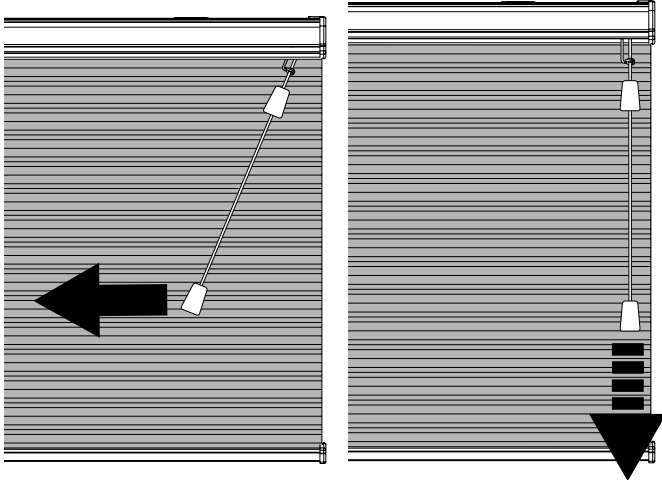

*To Lower the Shade:* Pull the cord toward the center of the shade and release.

*To Raise the Shade:* Pull the cord straight down with short strokes.

**Top-Down/Bottom-Up shades:** The right pull cord assembly operates the moving rail (middle rail). The left pull cord assembly operates the bottom rail.

**Two-On-One Headrail shades:** The right pull cord assembly operates the right bottom-up shade. The left pull cord assembly operates the left bottom-up shade.

If the shade should hit an obstruction as it is lowered, it will stop but may misalign the cords in each cord rout. This may cause the shade to be angled or tilted when fully raised.

To realign the shade, raise it slightly, then lower it completely to the sill. In some cases you may need to pull down gently on the bottom rail to get it to drop all the way.

If this is not done, the shade will remain angled or tilted and each time it is raised the tilt may increase.

*Note: If the shade is tilted when fully raised, do not pull harder on the cord when the shade is fully raised. It does not help alleviate the tilt, and may make it worse.*

## CARE AND CLEANING

Regular light dusting with a feather duster will suffice in most circumstances. For more thorough dust removal, the fabric may be vacuumed. A hand-held vacuum with low suction is recommended. Spot clean Soho™, Chelsea™, Tribeca™ and Washington Square™ semi-opaque fabrics by gently blotting with a soft, damp cloth or sponge. Use lukewarm water, mild detergent and light pressure.

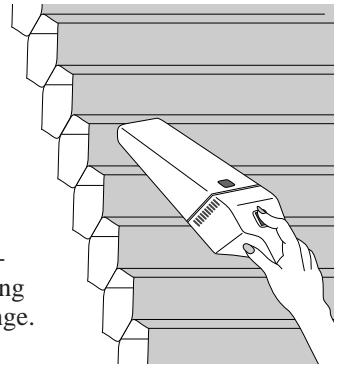

If you require a more comprehensive cleaning, a professional can ultrasonically clean the shade using a mild detergent solution.

**DO NOT IMMERSE THE HEADRAIL IN CLEANING SOLUTION.**

Allow the shade to dry in the completely lowered position.

**Do not sponge, spot clean, or ultrasonically clean Gramercy Park™, Park Avenue™, Park Avenue Eclipse™ or Tribeca Eclipse™ fabrics.**



# HunterDouglas

window fashions

hunterdouglas.com

Where Great Rooms Begin.

© 1999 Hunter Douglas Inc.  
® Registered trademark of Hunter Douglas Inc.  
™ Trademark of Hunter Douglas Inc.  
Patented in the U.S. and foreign countries.  
Additional U.S. and foreign patents pending.

Product Code No. 5109034000

rev.7/99

7/99 5C

