

# Installation and Care Instructions

Duette® Honeycomb Shades  
Applause® Honeycomb Shades

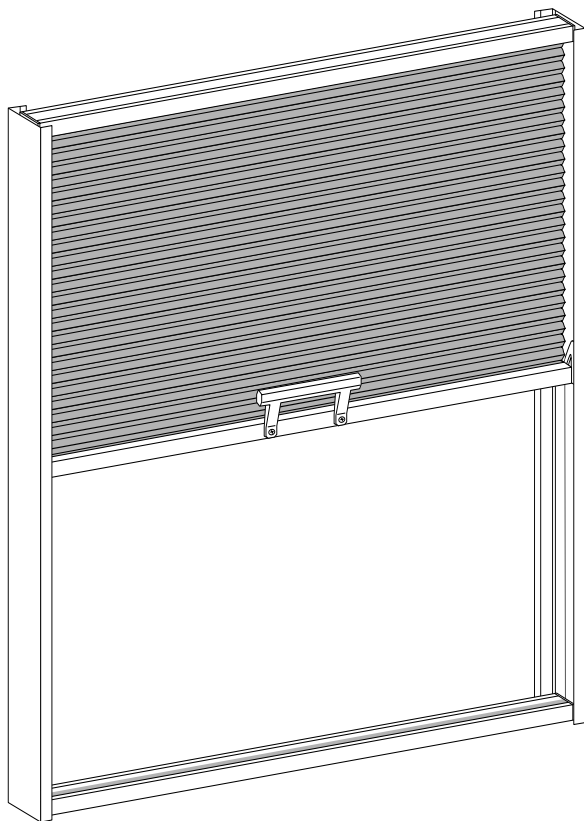

Simplicity™ Shades

**HunterDouglas**  
*window fashions*

**THANK YOU** for purchasing a Hunter Douglas product. Your new shade has been custom built for you from the highest quality materials. Once in your window, it will provide you with a lifetime of beauty and trouble-free use.

## Getting Started

- Remove the shade from the package. Keep the packaging until the shade operates to your satisfaction.
- Check the diagram to make sure you have the necessary parts.

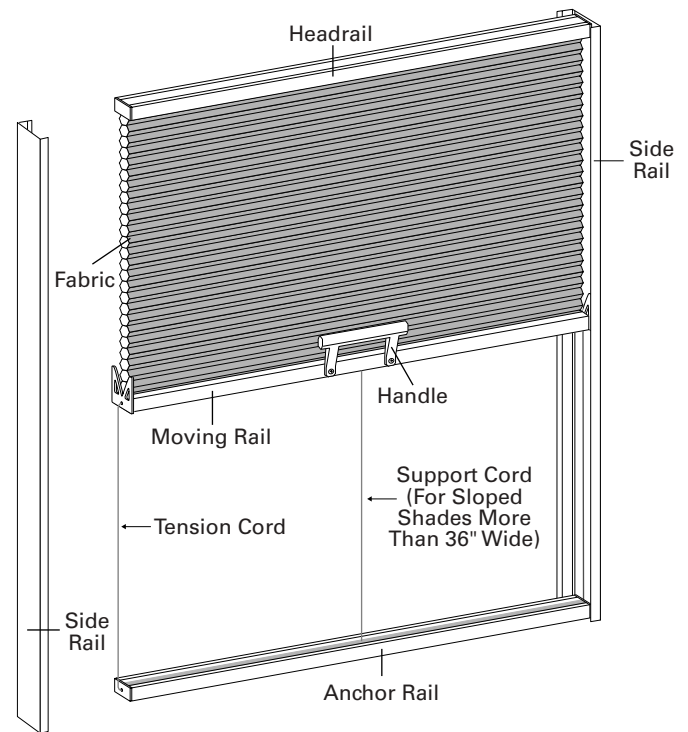

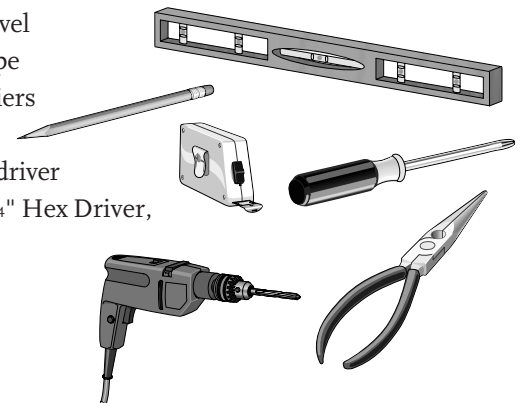

### Tools needed for installing your shade:

- Carpenter's Level
- Measuring Tape
- Needlenose Pliers
- Pencil
- Phillips Screwdriver
- Power Drill, 1/4" Hex Driver, and Drill Bits



For assistance, call the  
Hunter Douglas  
Customer Information Center at  
1-888-501-8364  
7:00 AM to 4:30 PM MST, Mon.-Fri.  
Visit our Web site at [hunterdouglas.com](http://hunterdouglas.com)

In addition, you will need fasteners designed to work with your specific mounting surfaces:

Mounting Surface	Fastener
Wood	No. 6 Hex Head Screws (Provided) 
Drywall, Plaster	Wall Anchors, Expansion Bolts (Not Provided) 
Metal	Sheet Metal Screws (Not Provided) 

Your hardware package may vary depending upon whether the shade is mounted inside or outside the window opening.

# 1 Mount the Installation Brackets

## Bracket Placement

- Position two installation brackets so their centerlines are 4 1/2" from the ends of the headrail.
- If your shade has a support cord, position a third bracket 1" to the left of the center of the headrail.

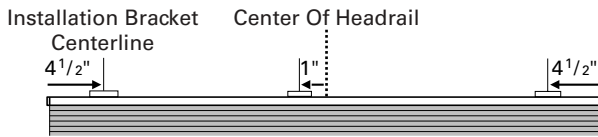

- Measure and mark all bracket centerlines.
- For outside mount applications, use the installation brackets to mount the anchor rail.
- For inside mount applications, attach the anchor rails directly to the sill with screws.

## Inside Mount Applications

The depth required for a fully recessed mount depends upon the pleat size.

**NOTE:** Add the dimension of obstructions (such as window cranks or handles) to the minimum depth.

### Depth Chart For Inside Mount Bracket Placement

Fabric Pleat Size	Minimum Depth	Flush Mount
3/8" Standard	7/8"	1 11/16"
3/4" Standard	1"	2 1/2"
3/4" Double, Triple Honeycomb	1 1/8"	2 1/2"

- Use one mounting screw to attach each installation bracket to the top sill of the window opening.
- Place the screws on the marked centerlines and align the brackets so their front edges are recessed 3/8".
- If the anchor rail does not have mounting holes, space installation brackets on the bottom sill the same distances as used for the top sill. Attach the anchor rail to the brackets.
- Use the rear hole of the bracket if the mounting depth is between 1/2" and 1".

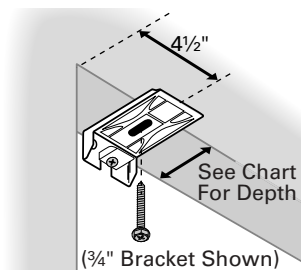

## Outside Mount Applications

Mount brackets using two screws for each bracket. Minimum height measurements for outside mounts:

- 5/8" for 3/8" brackets
- 1" for 3/4" brackets
- Use a carpenter's level to level and align the brackets.
- Center the brackets and attach each bracket using two screws.

Standard Bracket For 3/8" Pleat Size

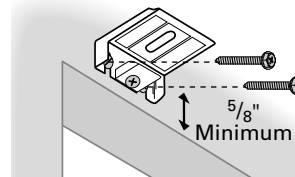

Standard Bracket For 3/4" Pleat Size, Double, And Triple Honeycomb

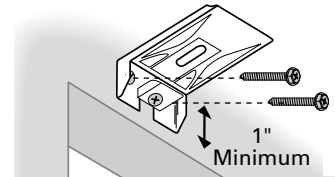

- Make sure the headrail brackets and anchor rail brackets are horizontal and parallel.
- Make sure the brackets for each rail are aligned at the same height.

# 2 Install the Headrail

**NOTE:** Do not remove the rubber bands that hold the headrail, fabric, and moving rail until after the side tracks are mounted (in step 5).

- With the front (colored) side of the fabric facing you, slide the headrail into the installation brackets.
- Fit the front lips of the brackets into the front groove on the top of the headrail.
- Snap the headrail into place.
- Tighten the tab screw on each bracket until it is snug. Do not overtighten the tab screw.

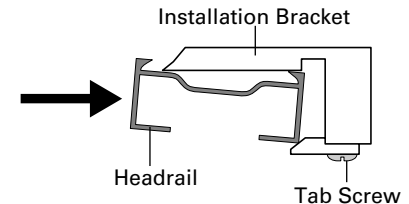

**CAUTION:** Make sure no fabric is trapped between the headrail and the installation bracket tabs.

# 3 Mount the Side Tracks

## Inside Mount

- Attach the side tracks to the inside of the window using the pre-drilled holes on alternate sides of the track centerline.
- For sloped installations, align the wide flange with the front edge of the window opening.
- For vertical installations, align the wide flange flush with the edge of the opening.
- Make sure the rails are centered within the side tracks.
- Make sure the side tracks are parallel by measuring the distance between them at the top and bottom of the window.

- If the side tracks are more than  $\frac{1}{4}$ " off of parallel, use wooden shims under the mounting screw locations, starting at the ends of the side tracks.

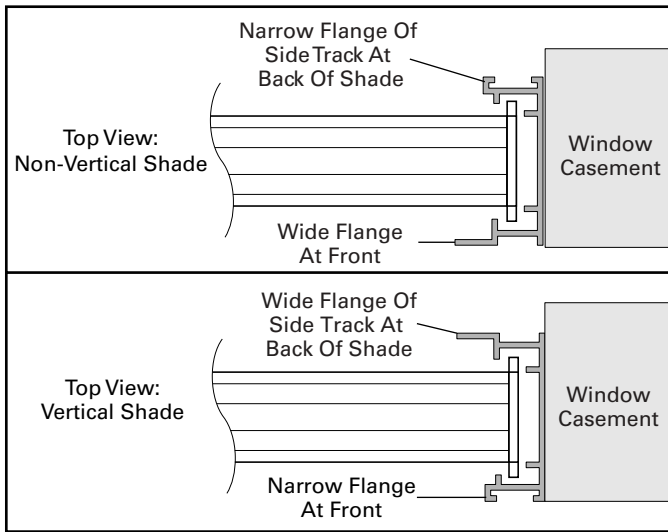

## Outside Mount

The narrow flange on the side tracks should be at the front of the shade.

Holes are drilled in the groove near the edge of the wide flange.

- Attach the wide flange to the outside of the window casement using the appropriate fasteners.
- Measure the distance between the side rails at the top and bottom of the window to make sure the rails are parallel.

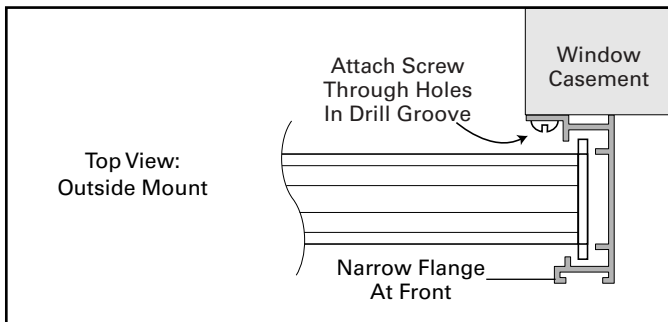

## 4 Install the Anchor Rail

**CAUTION:** Be careful not to tangle the cords.

- Cut the rubber bands that are holding the rails and fabric together.
- Lower the anchor rail to the bottom of the side tracks.
- Make sure the open side of the anchor rail faces up, with the spring and cords exposed.
- If the open side is covered by a fabric strip, remove it to make any shade adjustments.
- Outside mounts: Snap the anchor rail into the installation brackets.
- Inside mounts: Attach the anchor rail directly to the sill.
- Center the rail within the side tracks before direct mounting.

## 5 Adjust the Shade

### Tension Cords

The moving rail should slide easily, yet hold its position when it is released. Adjust the tension cords in the anchor rail if the moving rail does not slide properly.

- Move the slip knot to the right to increase the cord tension. Do not stretch the spring to a length greater than  $5\frac{1}{2}$ ".
- Move the slip knot to the left to decrease the cord tension.

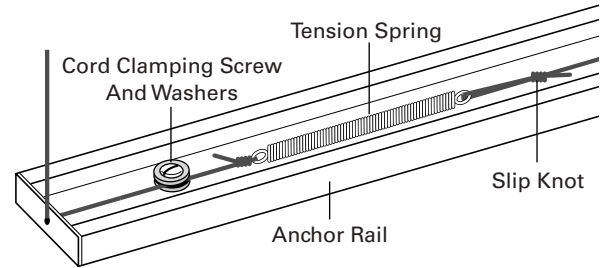

### Moving Rail

The moving rail should be parallel to the anchor rail so that the two rails make even contact when the shade is closed. Adjust the moving rail if it is not parallel.

- Loosen the cord clamping screw.
- Slide the cord between the two washers.

**CAUTION:** Do not adjust the cord tension while you are making this adjustment.

### Support Cord Tension (If Applicable)

If your shade has a support cord, it should be very taut. To adjust:

- Loosen the support cord clamping screw.
- Pull the cord through the two washers to the desired tension.
- Tighten the screw.
- Make sure the cord is held tightly between the two washers.

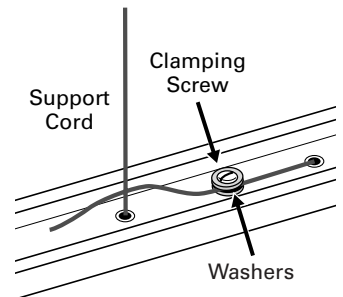

## 6 Final Assembly

- Fit the fabric strip into the anchor rail to cover the internal hardware.
- Attach the handle to the moving rail using the screws provided.

## 7 Remove the Shade

- Fully raise the shade.
- Unscrew the tab screw on each bracket to release the headrail.
- If you used brackets to install the anchor rail, unscrew the tab screw on each bracket to release the anchor rail.
- If you did not use brackets to install the anchor rail, remove the fabric strip, then remove the screws to release the anchor rail.

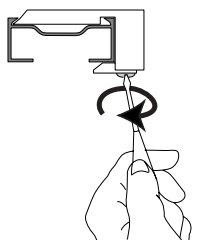

# 8 Care and Cleaning

Honeycomb shades are made of an anti-static, dust-resistant fabric which repels dirt and dust. For most honeycomb fabrics, the following options are available if your shade needs cleaning.

## Dusting

Regular light dusting with a feather duster is all the cleaning that is needed in most circumstances.

## Vacuuuming

Use a hand-held vacuum with low suction for more thorough dust removal.

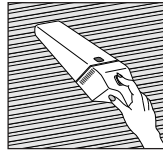

## Spot-Cleaning

- Prepare a solution of warm water and a mild detergent.
- Dampen a clean cloth in the solution and wring it out.
- Dab the spot with the dampened cloth until it is gone.  
**Do not rub the fabric.**
- Allow the shade to dry in the completely lowered position.

**CAUTION:** Do not spot-clean Applause Affinity®, Duette Batiste, Duette Royale™ Refined, Duette Royale Textured, or Duette Royale Refined Eclipse™ Fabrics.

## Deep Cleaning

- Immerse the shade in a basin or bathtub filled with a mild detergent.
- Rinse with clean water.
- Fully raise the shade and tilt to eliminate excess water.
- Reinstall the damp shade, lower it, and let it dry completely.

**CAUTION:** Do not immerse Applause Affinity, Applause Legends™ Blackout, Duette Classic Eclipse™, Duette Royale Refined Eclipse, Duette Elite Eclipse, Duette Majestic Eclipse, or Commercial fabrics.

## Ultrasonic Cleaning

Some Duette and Applause fabrics can be ultrasonically cleaned by a professional.

- Specify that a mild detergent solution be used.
- Never immerse the headrail in the solution.
- Dry the shade completely in the lowered position.

**CAUTION:** Do not ultrasonically clean Applause Affinity, Applause Legends Blackout, Commercial, Duette Classic Eclipse, Duette Royale Refined Eclipse, Duette Elite Eclipse, Duette Majestic Eclipse, or Duette Opalessence™ fabrics.

## Injection/Extraction

Honeycomb shades can be professionally cleaned using the injection/extraction method.

- The “dry method” is required for Duette Classic Eclipse, Duette Elite Eclipse, Duette Elite Eclipse, Duette Royale Refined Eclipse, Duette Majestic Eclipse, and Duette Opalessence Fabrics.
- If using injection/extraction for Batiste fabrics, specify that *no chemicals* are used (water only).

For more comprehensive cleaning instructions, call the Hunter Douglas Customer Information Center toll free at:

**1-888-501-8364**

# 9 Troubleshooting

PROBLEM	SOLUTION
The shade does not raise and lower evenly.	<p>Check the installation brackets. Make sure the shade fabric is not caught between the bracket tab and the headrail.</p> <p>Adjust the cord tension (see step 5).</p> <p>Check that lift cords are not pinched or tangled.</p>
The shade will not snap into the mounting brackets.	<p>Make sure mounting brackets are level. Loosen the tab screws slightly.</p>



**HunterDouglas**  
window fashions

hunterdouglas.com

*Where Great Rooms Begin.*

© 1997, 2003 Hunter Douglas Inc. ® Registered trademark of Hunter Douglas Inc.  
™ Trademark of Hunter Douglas Inc. Patented in the U.S. and foreign countries.  
U.S. and foreign patents pending.



PCN 5109141000

rev. 6/03

600-6/03